

X-Large

XL 6500

Instrukcja montażu



Przestrzegać wymiarów otworów!



Przestrzegać wszystkich pozostałych instrukcji montażu!

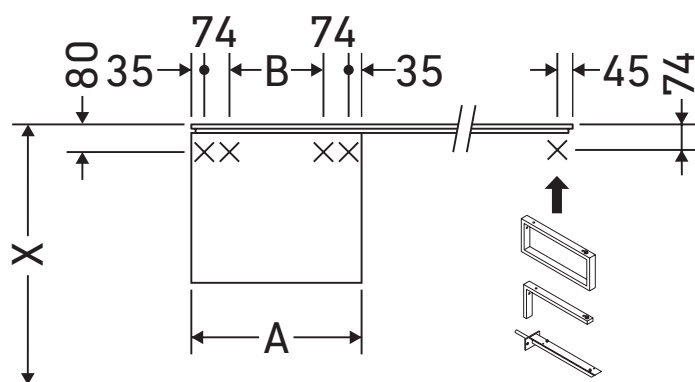

A	B
mm	mm
600	382

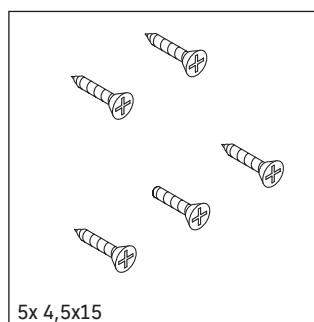
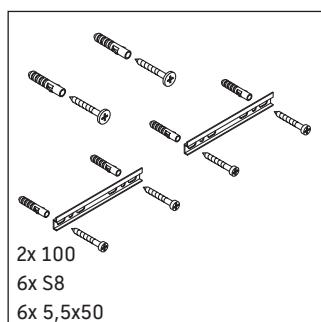
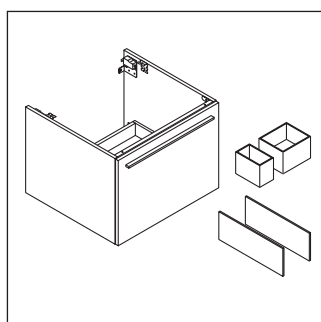

Wskazówki dotyczące użytkowania

Seria mebli łazienkowych odpowiada obowiązującym normom i dyrektywom w chwili dostawy i jest zaprojektowana do stosowania w łazienkach. Należy unikać bezpośredniego zroszenia wodą, np. podczas brania prysznica. Ceramika o szerokości powyżej 600 mm musi być przymocowana do ściany. Zmiany techniczne i optyczne prezentowanych produktów zastrzeżone.

