

DuraStyle

DS 6382

Instrukcja montażu

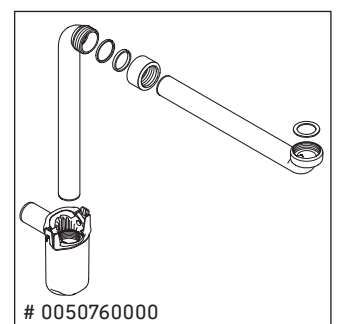
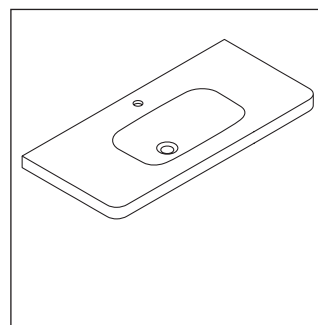
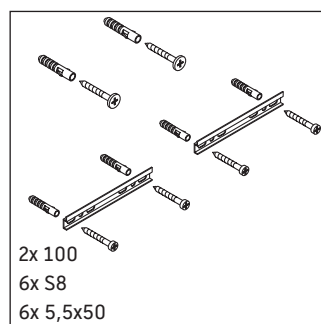
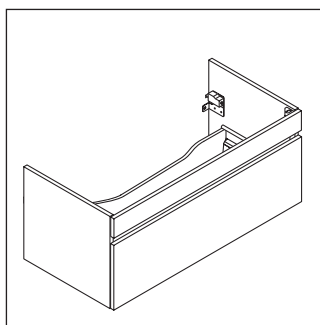
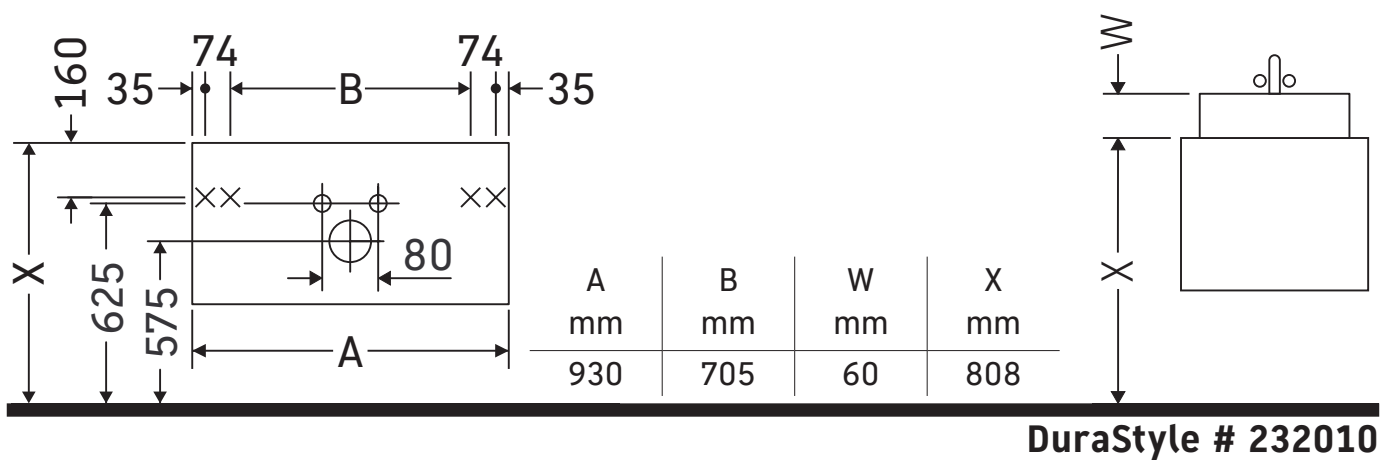

Wskazówki dotyczące użytkowania

Seria mebli łazienkowych odpowiada obowiązującym normom i dyrektywom w chwili dostawy i jest zaprojektowana do stosowania w łazienkach. Należy unikać bezpośredniego zroszenia wodą, np. podczas brania prysznica.

Zmiany techniczne i optyczne prezentowanych produktów zastrzeżone.

